

theLIA



Lighting Control: Mini Guide – Combining with Emergency Lighting

January 2019



THE LIGHTING INDUSTRY ASSOCIATION

OVERVIEW OF THIS MINI GUIDE

In many lighting installations the lighting serves a dual purpose, with luminaires operating as normal building lighting in normal conditions, plus in an emergency some of them illuminate to provide escape lighting.

- When the luminaires are operating as normal building lighting they will be controlled by a lighting control system.
- An effective lighting control system is important for an energy-efficient building and for building regulations approval.
- Under emergency conditions the escape lighting must illuminate quickly, reliably and unconditionally. Regular testing of the emergency lighting is also a legal requirement.

This guide outlines designs for a lighting installation that will serve both purposes without compromise. It is divided into two sections, describing:

- **Self-contained emergency luminaires** – luminaires with a self-contained emergency power source plus all other components required to provide light in an emergency;
- **Centrally supplied emergency luminaires** – here the power for multiple emergency luminaires comes from an emergency central power supply (CPS). (See also LIA IS12 – CPS)

In each section the guide describes normal operation, emergency operation and emergency testing.

This guide concentrates on the use of DALI control gear. This is because:

- energy efficient buildings call for dimming and DALI is the most widely used standard for dimming control;
- the DALI standard is unique in that it includes specific provisions to realise dual-purpose lighting in a vendor-independent manner.

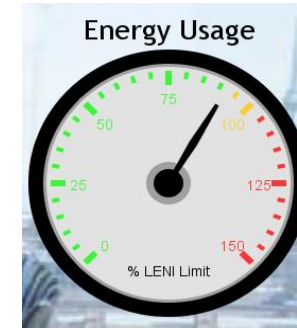

Detailed definitions of self-contained and centrally supplied luminaires are given in BS EN 60958-2-22 Clauses 22.3.8 and 22.3.9

This guide covers both luminaires with separate drivers for normal and emergency operation and luminaires in which one driver serves both functions.

SELF-CONTAINED EMERGENCY LUMINAIRES

Over the past 20 or so years, many dual-purpose luminaires have been built using 'conversion kits', adding a self-contained emergency power source. This arrangement now typically consists of the components shown on the right.

Under normal conditions the 'normal gear' drives the light source and is controlled by signals from the lighting control system – either a switched mains supply for luminaires without dimming or the combination of a switched mains supply and a dimming control signal.

A separate permanent mains supply powers the 'emergency gear'. Under normal conditions the emergency gear uses this supply to charge its battery.

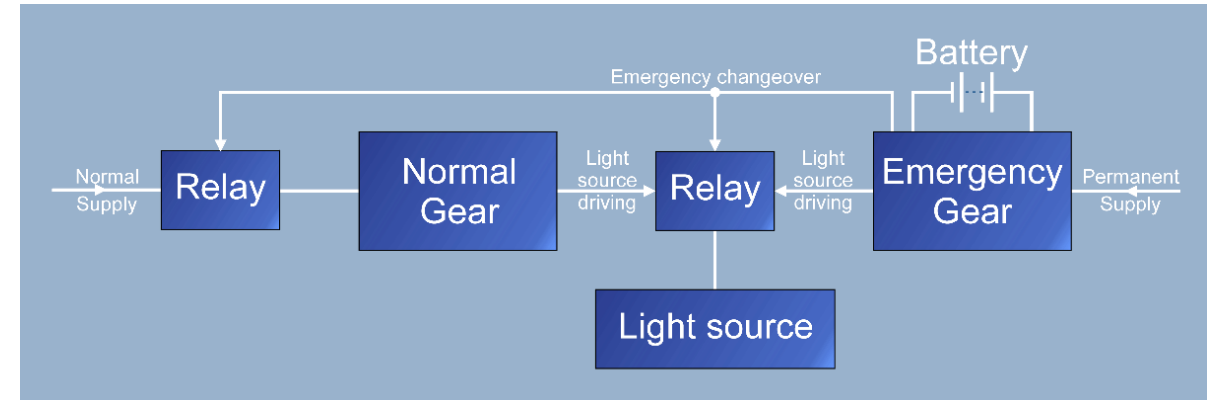

Upon loss of the permanent mains supply the emergency gear takes control of the light source and lights it from its battery supply. In a typical converted LED luminaire the emergency gear uses relays to:

- disconnect the normal gear from its normal power supply, to prevent damage to the normal gear; then
- drive the light source in place of the normal gear.

The emergency gear takes control of the light source unconditionally, regardless of the state of the lighting control system and normal gear.

Upon restoration of the permanent mains supply, the emergency gear releases its emergency changeover relays to allow the normal gear and lighting control system to resume normal operation.

TESTING SELF-CONTAINED EMERGENCY LUMINAIRES

Emergency testing typically consists of interrupting the permanent mains supply, for example via emergency test key switches, and then inspecting each luminaire to ensure that it is lit from its emergency power source.

- In some cases inspection would be manual, by visiting each luminaire during the test and checking that it was lit.
- In other cases the emergency luminaires would have been fitted with current or light sensors to allow correct emergency operation to be monitored remotely.



The arrangement of changeover relays described on the previous page is a hand-down from fluorescent luminaire technology, which usually had only a single lamp.

Some LED luminaires use a different arrangement where two separate light sources are driven independently by the two gears, so that no relays are necessary.

The two light sources may be physically separate or they may be combined on a single substrate, fed by independent connections.

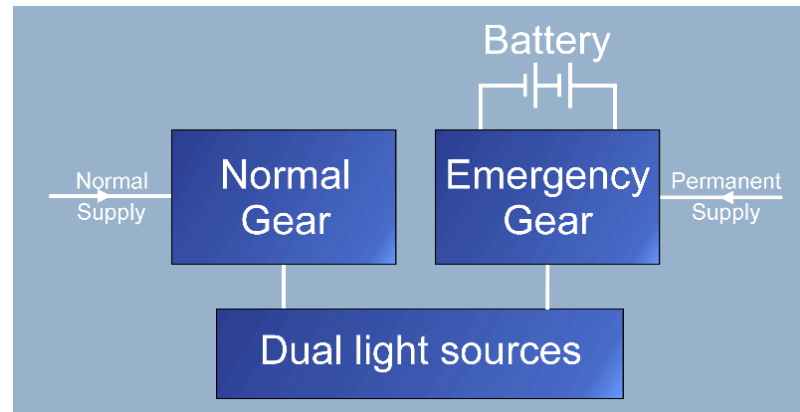

A typical arrangement of two light sources on a single substrate

DALI SELF-CONTAINED EMERGENCY LUMINAIRES

When a DALI controlled emergency gear is fitted to these styles of luminaire, the components are as before except that:

- the emergency gear has a DALI control interface;
- if the normal gear is also a DALI gear, it will have a DALI control interface; the control interfaces for both drivers may be connected via the same bus wiring.

In a fluorescent luminaire, the normal gear is generally called a ballast and the emergency gear an inverter, reflecting their functionality. The DALI standard and BS EN 61347 call them both control gear.

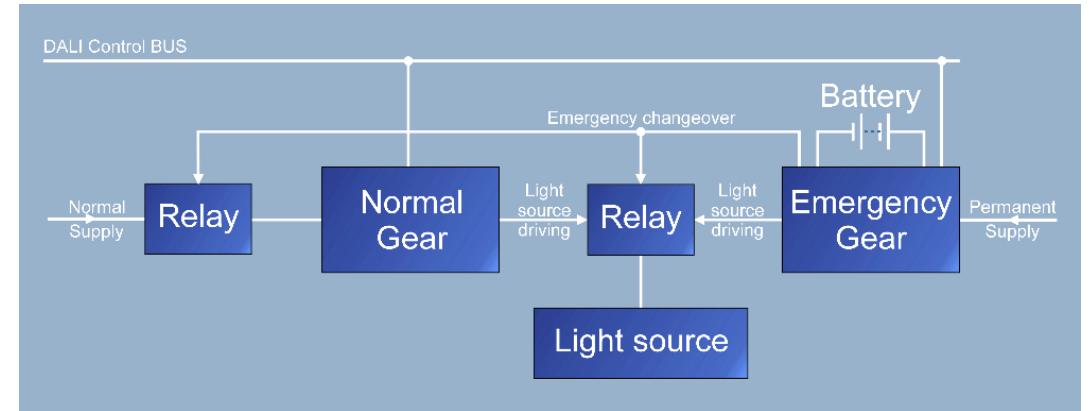

During normal conditions the normal gear drives the light source. Upon failure of the permanent mains supply the emergency gear takes over. In both these respects a DALI self-contained emergency luminaire behaves exactly like any other self-contained emergency luminaire.

The differences arise in emergency testing.

- Every emergency gear conforming to the DALI emergency gear standard IEC 62386-202 is able to carry out an emergency test when commanded across the DALI bus – either a short (function) test or a discharge (duration) test.
- The emergency gear carries out the test autonomously when requested to do so; it selects its battery as the power source during the test, so that there is no need to interrupt its permanent mains supply. Once the test is complete the test results can then be read over the DALI bus.
- In the event that the permanent mains supply fails during a test, the DALI emergency gear immediately stops the test and goes into full emergency operation, so that the requirement for the escape lighting to illuminate quickly, reliably and unconditionally is met.

DALI SELF-CONTAINED EMERGENCY FEATURES

DALI emergency gear provides a standard way for test results to be read from the gear and allows the results to be collected and recorded automatically. These results include the actual discharge time achieved, indicating the margin of failure in the case where the battery failed to power the light source for the required duration.

Each DALI emergency gear is individually addressable on its DALI bus and each gear can be commanded individually to carry out an emergency test. So rather than using a key switch to test all the emergency luminaires in one zone together (and run their batteries flat together) each emergency luminaire in the zone can be tested at a different time, thus ensuring the safety of the zone at all times.

If the emergency and normal drivers in a luminaire are both DALI gears, then each can be separately addressed on the same DALI bus. This allows common wiring to be used for both normal lighting control and emergency test control. During a failure of the permanent mains supply, the emergency gear acts autonomously to provide escape lighting, regardless of the state of the DALI bus.

The DALI standard allows additional emergency features to be configured as options. As an example, the emergency gear may be configured to continue to power the light source for a fixed time after the permanent mains supply has been restored.

Some DALI emergency luminaires may be used only for escape lighting in emergency conditions. In this case there will be no normal gear and/or emergency changeover circuits. The DALI emergency gear will be connected directly to the light source; its functions are exactly the same as described above.



Components of a typical emergency-only luminaire

A luminaire that lights only in emergency conditions is defined as *non-maintained* in BS EN 60958-2-22.

A luminaire that lights also at other times is termed *maintained*. Its behaviour at these other times will depend on the application. For example an exit sign in a theatre will be lit whenever the building is in use, whereas a luminaire in a meeting room may be lit only when the room is occupied and the natural light is insufficient. In both cases BS EN 60958 2-22 classes the luminaire as *maintained*.

DALI SELF-ACTIVATED TESTING

The test-on-command capability of DALI emergency gear is typically used by central emergency testing systems, including fully automated test systems.

Some DALI emergency gear also have the capability to activate their own tests at regular intervals, without the need for a command from an external testing system. Test results can still be read via the DALI bus, and these emergency gear can also typically indicate the result of the last test using an LED with flashing code sequences. This permits a simple manual test procedure – all that is required is to visit each emergency gear and check its LED on a regular basis.

The disadvantage of self-activated testing is that each emergency gear makes its own decision as to when to run a test and these decisions are often based on the time since the gear was first installed.

- If all the lighting in a zone was installed at the same time there is a risk that the emergency gear in the zone will discharge their batteries together one year later, thus rendering the zone unsafe.
- Also the spontaneous self-testing of a light fitting when a room is in use can disrupt activities in the room.

These are two of the reasons why the DALI standard includes the capability to disable self-activated testing.

The payback from a central emergency testing system comes from avoiding the labour costs of visiting each emergency fitting regularly; in a large building these can be considerable. In a DALI lighting control installation the testing communications infrastructure is generally in place, so only the cost of the central testing system needs to be added. The added benefit of a fully automated system is that it avoids a common human factors problem – lapses in carrying out routine tests.

Self-activated testing is an optional feature in DALI emergency gear (IEC 62386-202 Section 9.10), so you should check with each emergency gear supplier whether they support the feature, before adopting a scheme that relies on it.



COMBINED GEAR

Many dual-purpose luminaires contain separate normal and emergency gear. At the same time another arrangement is also becoming common for dual-purpose lighting - two separate gears are replaced by a single module that drives the light source in both normal and emergency conditions.

In the case of DALI gear, the IEC 62386-202 standard provides a definition of this type of operation, illustrated on the right. The behaviour of the module is defined in the DALI standard as follows:

- During normal operation the light output is controlled by normal DALI lighting control commands.
- A test that is requested via the DALI bus 'trumps' all these control commands; the module supplies the light source from its battery and carries out the test autonomously. At the end of the test, normal lighting control commands become effective again and the test results can be collected; the module has a single DALI address and common control wiring is used for both normal lighting control and emergency test control.
- Upon failure of the permanent supply the module immediately acts as an emergency driver, whether it was acting in normal control mode or emergency test mode and regardless of the state of the DALI bus. As before the requirement for the escape lighting to illuminate quickly, reliably and unconditionally is met.

Many luminaires can meet the escape lighting light level requirement without producing their full light output. Using a lower light level during emergencies has a direct effect on the battery capacity required. In the case of DALI, the standard has an option for an emergency light level to be stored in the emergency gear; this level will then be applied automatically during both true emergency operation and testing.

In order to exploit this feature, the lighting designer must ensure that the capacity of the battery fitted is appropriate for the combination of light level and emergency duration required.

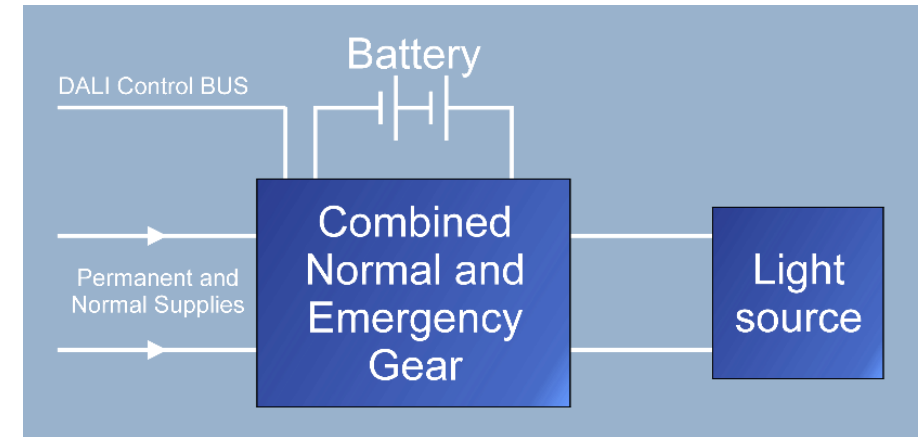

TYPES OF DALI EMERGENCY GEAR

DALI standard IEC 62386-202 defines different types of emergency gear that are appropriate to the different scenarios described so far, to assist lighting designers.

The types are:

➤ **maintained gear:**

- the gear drives the light source always, regardless of whether permanent supply is present;

➤ **non-maintained gear:**

- the gear drives the light source only when the permanent supply fails or when commanded to carry out a test;

➤ **switched maintained gear:**

- the gear drives the light source when the permanent supply fails or when commanded to carry out a test. At other times it responds to normal control commands to control the light source.

Emergency modules in this last category are subdivided into non-dimmable (only supporting lamp ON and OFF commands) and dimmable.

A supplier of DALI gear should be able to state which of these standard categories applies to each DALI emergency product.

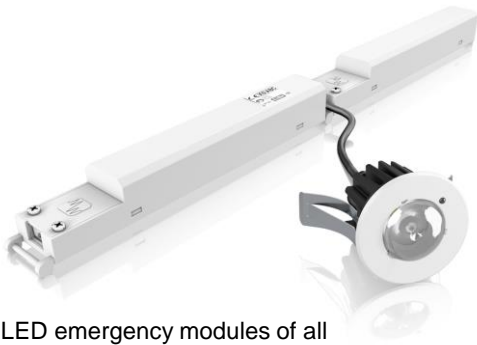

LED emergency modules of all these types often look identical.

Sadly these definitions for gears do not match the definitions in BS EN 60598-2-22, already mentioned, for complete luminaire fittings.

If the emergency gear is the only gear in the fitting, then the fitting will be non-maintained if the gear is set up as non-maintained; otherwise the fitting will be maintained.

- Correct transitions between normal and emergency modes depend on the correct design of this gear.

A fitting with separate normal and emergency gears will always be maintained.

- Correct transitions between normal and emergency modes depend on the emergency changeover arrangement

KEY DESIGN QUESTIONS

For all dual-purpose lighting systems, regardless of technologies and techniques that they employ, there are some key questions that the designer must be able to answer. The material so far presented should make the importance of each of them clear:

- when lighting is being operated under normal conditions by a lighting control system, how does the design ensure that fail-safe emergency escape lighting is provided reliably and promptly in an emergency?
- after the emergency condition is over, how does the design ensure that energy-efficient normal control of the lighting is resumed?
- how will emergency testing be carried out?
- in the event of an emergency that occurs during testing, how does the design ensure that emergency escape lighting is provided reliably and promptly?

Some of these questions may be answerable by reference to the design of each individual dual-purpose luminaire, whilst others may require consideration of the whole system installation. In the next sections of the guide we will consider centrally-supplied emergency luminaires – for centrally-supplied schemes all these answers are likely to require consideration of the whole system.

There are two key choices in relation to emergency testing:

- will testing be initiated manually or automatically?
- will tests results be collected and recorded manually or automatically?

In general large installations tend to employ more automation and small installations less. However every case requires assessment on its own merits. For a dual-purpose lighting system, the most important thing is that the testing regime must be a part of the overall lighting system design.

The use of automation does not allow a building manager to dispense with periodic equipment audit. A fully tested emergency luminaire is no use if it is hidden behind a bookcase.

CENTRALLY SUPPLIED EMERGENCY LUMINAIRES

The simplest dual-purpose luminaire arrangement for central supply schemes is shown on the right. It has typically been used for non-dimming luminaires, i.e. fitted with normal gear that drives the light source to full output whenever supplied with mains power.

In normal operation the dual-purpose luminaire is controlled by a switched supply, e.g. from a Lighting Control Module. The switched supply is fed through an emergency changeover relay controlled by the normal (unswitched) supply.

- For as long as the normal supply is present the relay allows the Lighting Control Module to switch the luminaire on and off, so that it is under the control of the lighting control system.
- If the normal supply fails, the relay immediately connects the emergency supply to the gear, which lights the luminaire to provide emergency escape lighting.

Emergency testing can be carried out by interrupting the normal supply, using for example key switches as for self-contained luminaires. Inspection can be manual, by visiting each luminaire during the test and checking that it was lit.

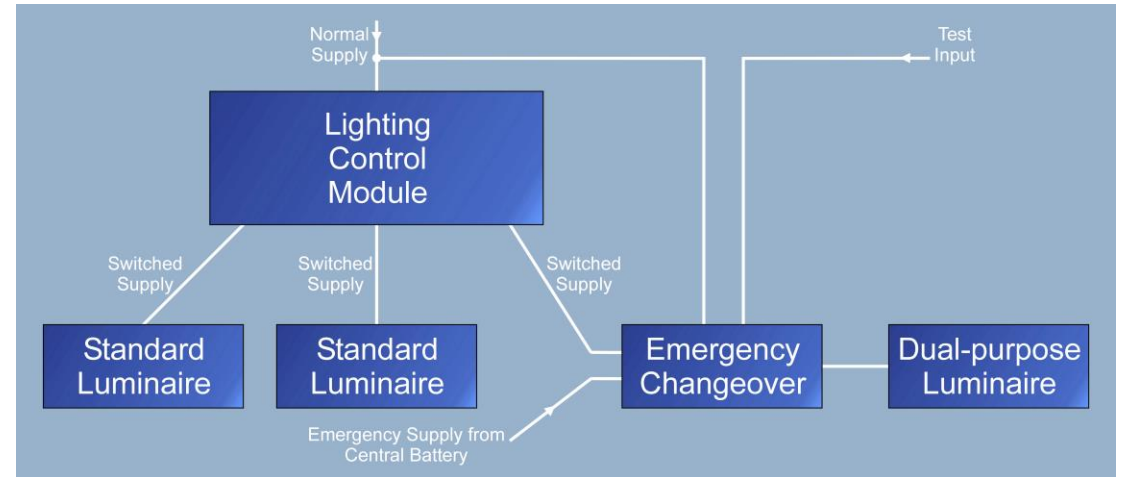

However the emergency lighting cannot be tested in separate zones. The reason is that the test must demonstrate (BS EN 50172/BS 5266-8) that the central battery can supply all the lighting at once and for the required duration in the event of a power failure. Hence the normal supplies need to be interrupted simultaneously in all the zones supplied by the battery.

For this reason the emergency changeover relay is sometimes fitted with an additional emergency test input. This input causes the relay to switch to emergency supply on demand. This requires an additional input (typically low voltage) to be taken to every dual-purpose luminaire.

SIMPLE AUTOMATIC EMERGENCY TESTING

The advantage of the arrangement just described is that it is fairly simple to understand.

The disadvantages are that:

- each dual-purpose luminaire must be connected to two mains supplies and contain its own changeover relay;
- in this arrangement, an automatic emergency test is successful if a high proportion of the emergency luminaires are lit from the emergency supply throughout the test; this is normally determined by checking the supply current out of the central battery (BS EN 62034). Such a test does not identify which emergency luminaires are lit or whether more than one luminaire in a single building compartment failed to light;
- operation with most types of dimming ballasts is more complex, since the emergency supply must be accompanied by an emergency dimming control signal.

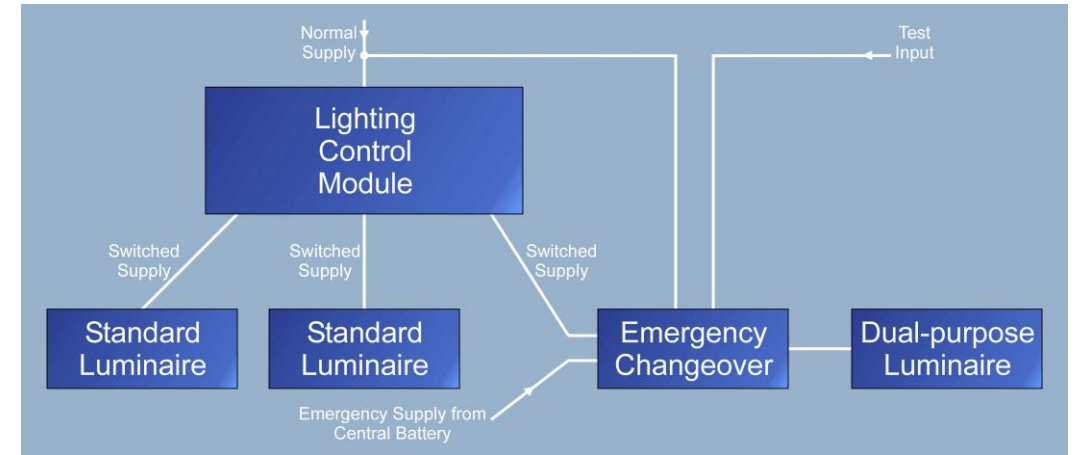

Otherwise a gear that was off before the power failure will not receive an 'On' signal. Since dimming gears are increasingly required for energy efficiency and for building regulations approval, this is an important issue.

Checking the supply current out of the central battery is sufficient to meet the testing standard BS EN 62034. By fitting current or light sensors to each emergency luminaire and wiring a communications bus to each one, each individual emergency luminaire can also be checked and there are some systems that perform automatic emergency testing in this way.

The cost of this approach is significant and can be reduced by the techniques that follow.

DALI CENTRALLY-SUPPLIED EMERGENCY LUMINAIRES

The DALI standards committee recognised that there was an opportunity to simplify the design of dual-purpose luminaires and so every DALI-compliant normal gear contains a feature that supports dual-purpose luminaires.

A DALI system for emergency lighting requires no changeover relays or dual mains supplies to the emergency luminaires.

The dual-purpose luminaire consists of a DALI normal gear fed from the permanent supply. We will call this a 'DALI permanently-fed gear' in the following sections.

The overall system arrangement is shown on the right.

This arrangement makes use of an increasingly common feature of central battery units, shown above and known as central battery 'changeover mode' (BS EN 50171). This means that the central battery unit contains the changeover device which switches over from normal supply to battery supply automatically in the event of a mains failure. The supply to the emergency luminaires is energised at all times. Only a single mains supply and no changeover relays are required at each dual-purpose luminaire.

The DALI standard provides the solution to the only remaining question: how to make the dual-purpose luminaires light automatically when the normal supply fails.

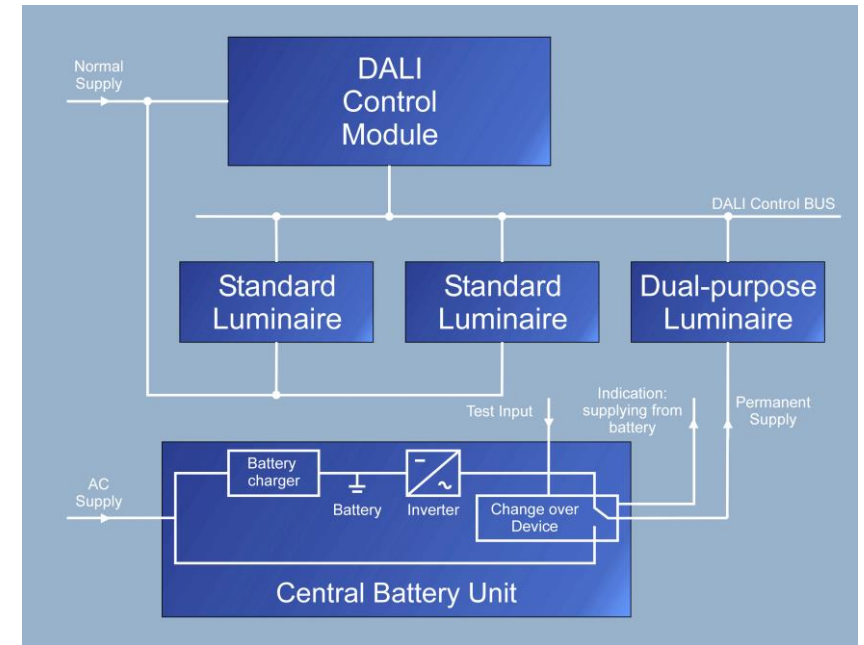

COMPLIANCE WITH STANDARDS AND REGULATIONS

The solution: every DALI normal gear will light its light source automatically and immediately when either:

- the DALI signal voltage drops below its permitted level for 0.5 second (termed '**interface failure**'); or
- the gear receives no DALI command for 0.6 second after it first receives mains power (termed '**power-on**').

Both of these cases are important for emergency luminaires, since the central battery 'changeover mode' may involve a temporary loss of power (invoking the 'power-on' case) or it may be instantaneous (invoking the 'interface failure' case).

To make the scheme work, the DALI signal must disappear in the event of normal supply loss. This is simply arranged, as shown on the right, by using the same normal supply circuit that supplies the non-emergency luminaires in each building 'compartment' (room, corridor etc.) to power the DALI control module that controls all the luminaires in that compartment. Loss of normal supply causes loss of DALI control voltage and so either the 'power-on' or the 'interface failure' mechanism will operate.

Automatic illumination of escape lighting is thus achieved without relays and without any signalling to the DALI gear. Each gear makes its own autonomous decision to light its lamp, leading to a highly reliable system.

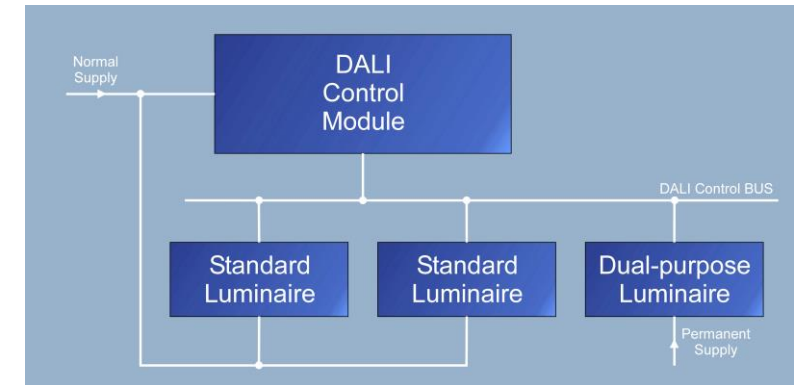

Once normal supply is restored, the lighting control system resumes normal control of the gear via the DALI control module – this will include restoring any dimming level settings that were overridden when the DALI signal disappeared.

Just like DALI emergency gear, DALI permanently-fed gear can be divided into the operating categories maintained, non-maintained and switched maintained. However in the case of a DALI permanently-fed gear, the category for a gear depends entirely on what commands the lighting control system sends the gear when normal supply is present. In all cases the luminaire will light when normal power is lost.

The figure above shows a dual-purpose luminaire, i.e. switched maintained. If it were a non-maintained luminaire, i.e. emergency-only, it would still be connected to the DALI control bus in exactly the same way, so that loss of normal supply results in loss of DALI signal in the compartment and hence causes the emergency lamp to light.

SIZING THE CENTRAL BATTERY

A dual-purpose luminaire may be required to produce 500 lux on a working surface during normal conditions, whereas emergency escape lighting may call only for 1 lux along the centre line of escape routes.

A combination of centrally fed emergency luminaires and the battery that feeds them constitutes a single system; its design involves sizing the battery capacity for the required load and emergency duration. Where full light output is not required under emergency conditions, setting a reduced emergency output level affects the required battery capacity and hence the cost of the system.

Most DALI gears allow reduced light levels for power-on and interface failure to be stored in the gear. If for example 50% output power is stored, the gear will go to this level automatically upon loss of DALI control, regardless of whether the light level was previously 0, 25% or 100%.

The DALI standard says that the range of reduced emergency output levels available will be the same as the range of dimming levels available during normal operation.



If a faulty gear is replaced, the replacement must have the reduced levels stored in it. You should ensure that some procedure is in place to do this. Some automatic test systems will check and correct these levels on demand and as part of routine testing.

Some emergency standards call for particularly fast response of emergency lighting to a power loss in certain building areas (e.g. 0.5 seconds for a treatment room in BS 5266-1).

Since the two DALI automatic lighting mechanisms have different reaction times, the faster of the two ('interface failure') can be ensured by specifying a central battery whose changeover mode is virtually interruption-free.

Central batteries are available with changeover times of around 2ms.

TESTING WITH DALI CENTRALLY-SUPPLIED EMERGENCY LUMINAIRES

The arrangement for emergency testing uses the same wiring as for emergency operation.

A test is performed without breaking any of the supplies, by instructing the central battery unit to supply the permanent circuits from its battery supply. The central battery unit provides a standard output signal (BS EN 50171) which informs the lighting control system that it is supplying the lighting from battery.

Since there is no normal supply failure, the lighting control system is still in control of the permanently-fed gear. It can therefore command each gear to light at its power-on/interface failure level. This produces the true emergency load for the central battery. Once the test is complete the lighting control system can return each permanently-fed gear to its normal light level.

In the event that a normal circuit fails during a test, the DALI control signal for that circuit will be lost and the affected luminaires will provide escape lighting automatically.

The DALI standard provides the following benefits for emergency testing:

All DALI gear provide feedback to indicate both the current light output level and whether there is a light source fault. During an emergency test the actual output level of each individual emergency luminaire can be confirmed as part of the test, giving the precise location of any luminaire fault, without fitting additional sensors or other components.

In normal supply conditions the DALI bus allows all luminaires, both emergency and normal, to be monitored continually. Light source faults can be identified without waiting for the next emergency test; also the failure of any local circuit, whether normal or emergency, can be identified without waiting for the next emergency test.

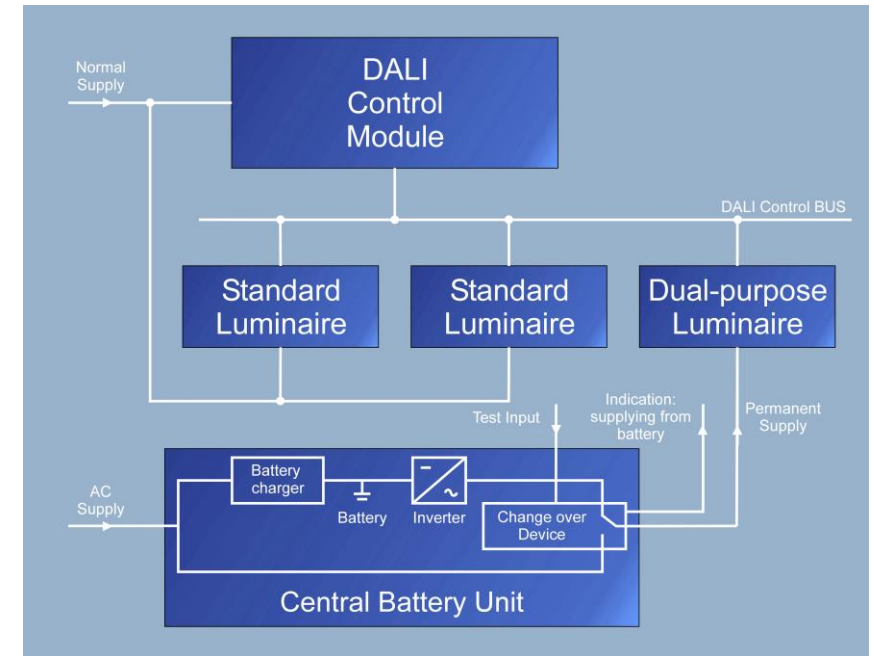

DALI SINGLE PORT CONTROL IN CENTRALLY-SUPPLIED SYSTEMS

Not all DALI lighting systems are wired with a control bus. In some cases a Lighting Control Module has a point-to-point connection to each luminaire. In this case the arrangement for mixed dual-purpose and normal luminaires is as shown on the right.

Emergency operation and emergency testing in this arrangement are exactly the same as for multiple DALI gear wired using a control bus.

It is possible to carry out manual testing with DALI permanently-fed gear, whichever of these wiring schemes is adopted – the test will consist of breaking the normal supplies and visiting each emergency luminaire during the test, to check that it is lit.

In a manual test environment some of the extra features described previously are unlikely to be available, for example reduced emergency light levels.

The DALI standard specifies that 'power-on' and 'interface failure' output levels will be set to 100% when a gear leaves the factory. This means that no special configuration tools are required to ensure the standard emergency operation in each luminaire.

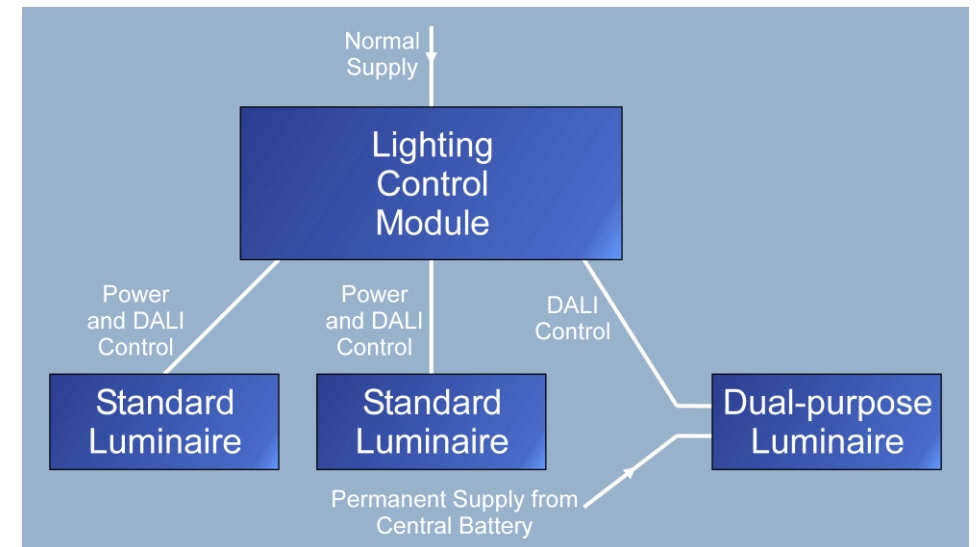

LOCAL CHANGEOVER RELAYS

In some configurations a DALI emergency installation is combined with local changeover relays, for example one relay per normal supply circuit.

Note that the changeover relay does not interrupt the DALI control signal:

- during failure of the normal supply this is unnecessary provided that the DALI control module is fed from the normal supply circuit as shown;
- during testing, interruption of the DALI control signals would prevent individual gear faults being identified.

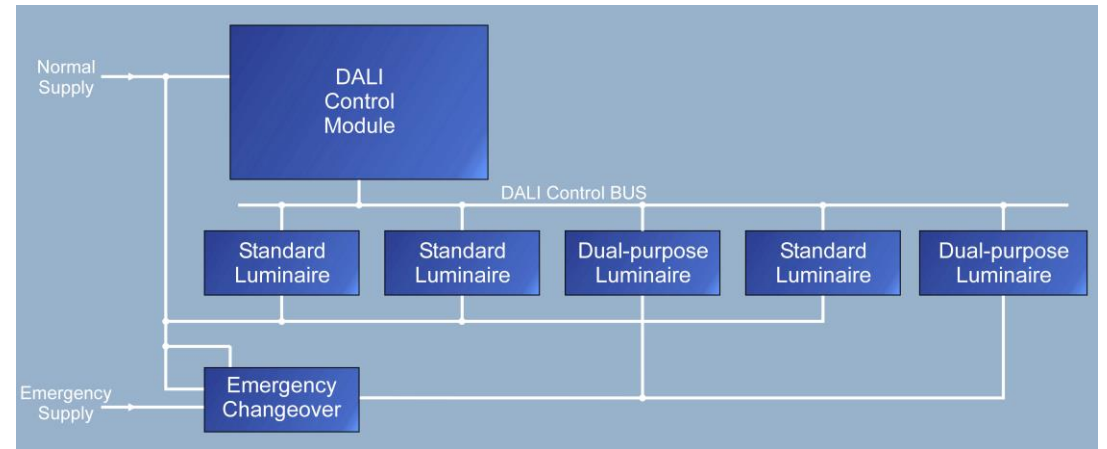

Since the DALI control signals are not interrupted during testing, the test system can – **and must** – command the gear to their correct emergency levels.

A configuration with changeover relays is tested in the same way as for a DALI permanently-fed configuration without changeover relays, except that an additional test is required. This is to ensure that the changeover devices have all operated and that there is in fact a representative load on the central battery during testing.

Correct operation of the changeover relays is normally determined by checking the supply current out of the central battery.

OPERATION ACROSS MULTIPLE CIRCUITS

As well as being activated by a total failure of the normal supply, emergency lighting in any building compartment must also light on failure of the individual supply circuit to that compartment (BS EN 50172/BS 5266-8). This is guaranteed in the DALI emergency arrangements shown so far, by ensuring that the same circuit powers both the normal lighting in the compartment and the DALI control module that controls the lighting in the compartment.

Sometimes more complex arrangements are required.

An example is shown here.

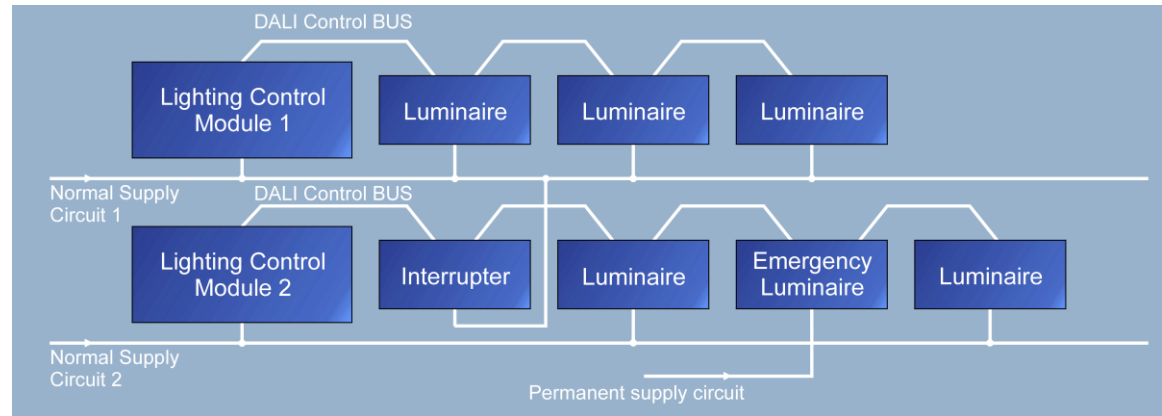

In this example an office has high power luminaires for use during normal working hours, powered from Circuit 1, plus low power luminaires for security and cleaning staff, on Circuit 2. Some of the low power luminaires also serve as emergency lighting. This schematic allows the emergency lighting on Circuit 2 to come on in the event of failure of Circuit 1.

The requirements of BS EN 50172/BS 5266-8 can be met by inserting an interrupter relay into DALI control bus 2, to interrupt the bus when Circuit 1 fails. A similar approach can be used in cases where luminaires controlled by a single DALI control bus are powered from more than one circuit.

Wherever possible it is recommended to stick to the simpler approach of *one compartment, one normal circuit* for DALI systems, since this makes the correct functioning of emergency lighting less complex both to design and to certify.

SPECIFYING DALI GEAR

In all designs affecting safety it is important that the components employed conform to the appropriate standards.

When using the techniques described in this guide, DALI modules performing emergency lighting functions must conform to the appropriate DALI standards, currently:

- IEC 62386-102 Ed 1 or 2 for normal gear;
- IEC 62386-202 Ed 1 for emergency gear.

These standards each include a series of test sequences that a module must pass as a prerequisite for DALI compliance. A standard DALI testing system is available to run these tests and testing systems are held by test houses and other organisations.

In selecting DALI modules, a designer should ask for a statement of compliance to the relevant DALI standard. Some DALI features have been indicated in this guide as being optional. Where a design makes use of optional features, the designer must ensure that the individual products selected offer these features and are commissioned correctly.

Technical footnotes

The 'interface failure' mechanism in a DALI gear uses a 'system failure' register to dictate the level at which the gear must light upon interface failure. DALI 'system failure' and 'interface failure' can be regarded as the same thing.

The latest ratified version of IEC 62386-102 is Ed 2, also commonly known as 'DALI-2'. However a DALI-2 version of IEC 62386-202 is still at an early stage of preparation. So for emergency gear IEC 62386-202 Ed 1 is current and is specified above. It calls up the relevant parts of IEC 62386-102 Ed 1, not Ed 2.

All the features described in this guide are available from DALI products conforming to IEC 62386-102 Ed 1 and/or IEC 62386-202 Ed 1. DALI-2 normal gear is suitable but is not required to achieve the functions in this guide.

As a result of cooperation between various standards bodies, the DALI standards are also adopted as BS EN 62386.

Many vendors sell gear that are suitable for multi-protocol use, so that they may be usable in DALI and other environments. None of the DALI techniques described in this guide depend on any proprietary extensions to the DALI standard. At the lighting control system level, the designer may wish to ask for a statement that the design depends purely on DALI standard operation, to ensure interoperability with all DALI standard gear.



OTHER TECHNIQUES

This guide has concentrated on the use of DALI control gear, because:

- energy efficient buildings call for dimming and DALI is the most widely used standard for dimming control;
- the DALI standard is unique in that it includes specific provisions to realise reliable dual-purpose lighting in a vendor-independent manner.

In the case of centrally supplied emergency luminaires, a DALI gear will go to its power-on or interface failure level and stay there on loss of the DALI signal. It does not matter what dimming level was set before the DALI signal disappeared or if any fade was in progress at the time.

Automatic illumination of escape lighting at its correct dimming level is achieved without relays and without any signalling to the DALI gear. Each gear makes its own autonomous decision to light its lamp, leading to a highly reliable system. This is preferable to a design which relies on some communication from some external controller, where both the controller and the communication path must be sure to operate reliably under all hazardous conditions which call for emergency lighting.

There are of course many alternative approaches to DALI. In a dimming environment each has to solve the same problem: how to ensure that when the normal supply fails each emergency luminaire is lit at its correct level, in a fire-proofed fail-safe manner. As examples:

- for a luminaire with 1-10V control for dimming:
 - how will the 1-10V control be driven?
- for a luminaire with wireless control for dimming:
 - can both the transmitter and the radio path be relied upon?

And then when the normal supply returns, for ongoing energy efficiency, the lighting control system must be able to resume full control of dimming.

When evaluating a particular lighting technology as the basis for a dual-purpose lighting scheme, it may be helpful to run through the checklist on Page 10 and each of the problems that have been solved in this guide, checking:

- how do I solve the same problem with my chosen technology?

WIRELESS CONTROL

There are a wide range of wireless technologies with a capability to control non-emergency lighting. Most systems described as 'Internet of Things lighting' (IoT) use wireless communication. Two strong motivations for wireless control are:

- retrofit of existing buildings built without lighting controls - controls can be added using the existing mains wiring;
- as every smart phone is Bluetooth enabled, building occupants expect to use an app to control their own lighting.

Lighting controls and emergency lighting pose different challenges in a wireless environment:

- there are open standards for lighting controls, such as Bluetooth mesh. For installations of any size, design issues are response time and reliable communication. The radio environment will be subject to interference from other systems and attenuation from physical obstacles in a building.
- for emergency lighting, radio communications should be used only for testing, not operation. Response time is thus much less critical. However there are no open standards for wireless-based testing. A standard for DALI operation over Bluetooth mesh (IEC 62386-104) is close to release. Vendors may offer emergency wireless gear using this standard in the future.

All the questions in the checklist on Page 10 must be answered for a wireless solution, just as for any other solution. Two other matters should also be considered:

- if existing mains wiring is to be used, does it provide suitable normal and emergency supplies, including any relevant fire resistance requirements;
- how will communications security be put in place and managed for the lifetime of the installation?

Wireless systems raise issues of security because of problems of unauthorised access over radio. With recent well-known cases of IT systems being hacked either to control them or to prevent them from operating, a wireless control system that can be hijacked from an adjacent building is unlikely to be acceptable; radio waves have an annoying habit of travelling long distances when not wanted.

For normal lighting, unwanted intrusion into the control system may impact an organisation's operation. But emergency lighting is a safety system, so that unwanted intrusion is a more serious matter. Most wireless systems are capable of being configured for secure operation, using authentication and encryption techniques. In some cases, such as Bluetooth Mesh, security is mandatory. In many other cases wireless systems ship from the factory and can also operate with no security configuration. For a wireless emergency lighting system, allowances must be made for initial configuration and ongoing maintenance of a security regime.



STANDARDS, STANDARDS, STANDARDS

The purpose of this guide is to provide an insight into the design of dual-purpose lighting. It is not an alternative to understanding and complying with all the standards and regulatory requirements relating to both normal and emergency lighting:

- for normal lighting, these standards mainly concern the level and quality of artificial lighting and its energy efficiency;
- for emergency lighting, the main issues are quick, reliable and unconditional illumination of escape lighting, plus a regular testing and maintenance regime that itself does not jeopardise building safety.

The most successful dual-purpose lighting schemes will start from a single complete specification that addresses all of these issues and will be realised by a systems integrator with responsibility and access to the skills to cover all of the requirements.

This guide does not attempt to list all of these requirements, but the following items should be on the checklist for any dual-purpose lighting scheme:

- Requirements for normal lighting: BS EN12464-1; Building Regulations Part L
- Requirements for emergency lighting: BS 5266-1 and BS EN 50172/BS 5266-8
- Where automatic testing is to be used: BS EN 62034
- Where a central emergency power supply is to be used: BS EN 50171
- Is the quality of the emergency supply adequate for correct operation of all luminaire functions?
 - For example is its harmonic content compatible with the dimming control mechanism employed?
- Do the design and the components employed provide both safe, reliable escape lighting in an emergency and resumption of normal lighting control after the emergency has passed?
- How will this be demonstrated during commissioning, along with operation in normal and emergency modes?
- Does the maintenance team have sufficient information to ensure that all replacement components are consistent with the design requirements and that they can carry out any software or security configuration requirements?

theLIA



This mini guide has set out what can be achieved by combining a lighting control system with emergency lighting. To find out more detail on the design, specification, procurement and installation of a control system and emergency lighting system, as well as the practical issues and technologies available, please contact the Lighting Industry Association or go to www.thelia.org.uk to find out about further guides and training courses. For emergency lighting guidance, please also refer to the ICEL technical statements within the LIA website.

This guide was produced by members of the Controls Equipment Technical Committee (CETC) of the Lighting Industry Association. © Lighting Industry Association 2019 - All Rights Reserved

This document contains general information about lighting controls. In assessing the suitability of any specific product or installation the user must make his own judgement and/or take appropriate advice. Neither the Lighting Industry Association Ltd, nor any person acting on its behalf, makes any warranty of representation, expressed or implied with respect to the information contained in this document, or assumes any liability with respect to the use of, or damages resulting from, the use of this information for a specific application, project or installation.



THE LIGHTING INDUSTRY ASSOCIATION